

# Team Three

Andrea Yip

Chriz Miller

Daniel Garnier

Emily Hanson

Faisal Bashir

Mark Bain

Sandra Pereira

Stephanie Cheng

# Concept

# Concept

*“Tell a story.”*

# Concept

**“Tell a story.”**

**“Meet them where they are at.”**

**Where are they?**

# Where are they?

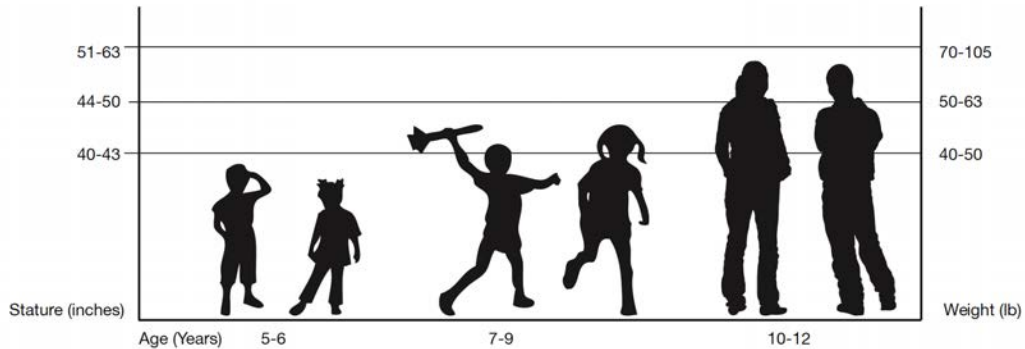

**What story?**

# What story?

Food ▷ Waste ▷ Nutrients ▷ Food



# What story?

Food ▷ Waste ▷ Nutrients ▷ Food

Solar Energy ▷ Plant Energy ▷ Human Energy

# What story?

Food ▷ Waste ▷ Nutrients ▷ Food

Solar Energy ▷ Plant Energy ▷ Human Energy

Seed ▷ Plant ▷ Harvest ▷ Transport ▷ Market ▷  
Plate ▷ Compost ▷ Soil

**Story of**

**Cycles**

# Super Cycles

How can a space show cycles?

How can a space show cycles?

**Make it Circular**

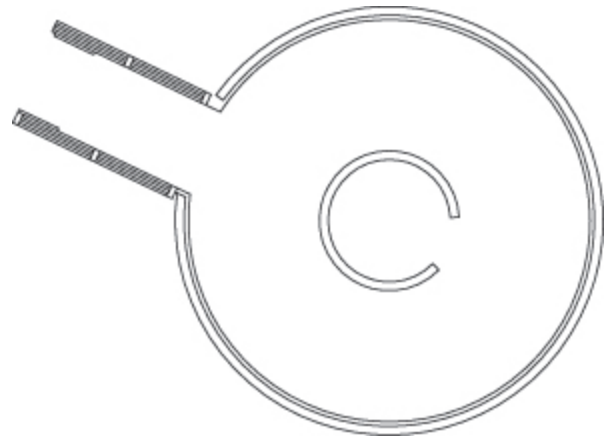

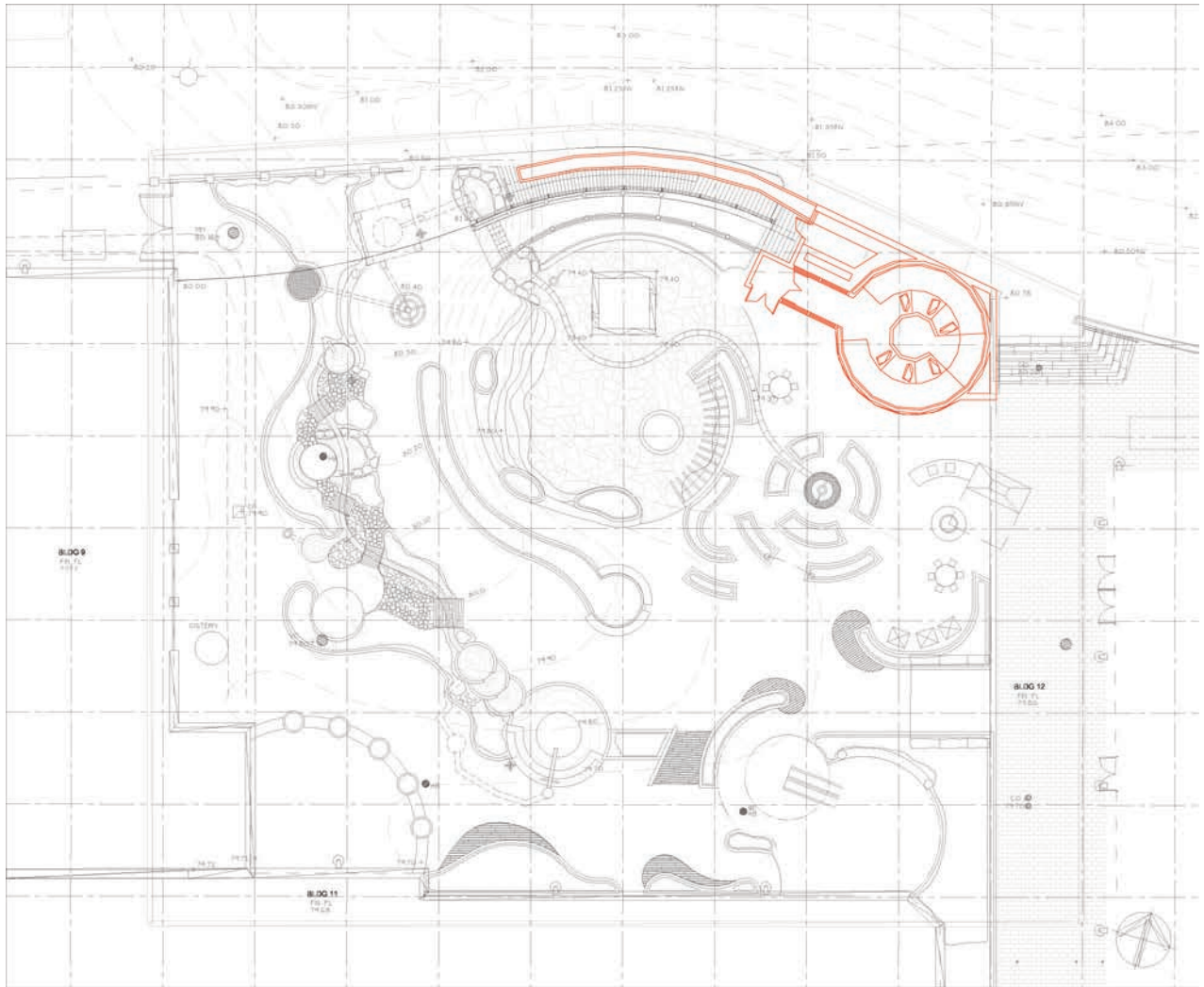

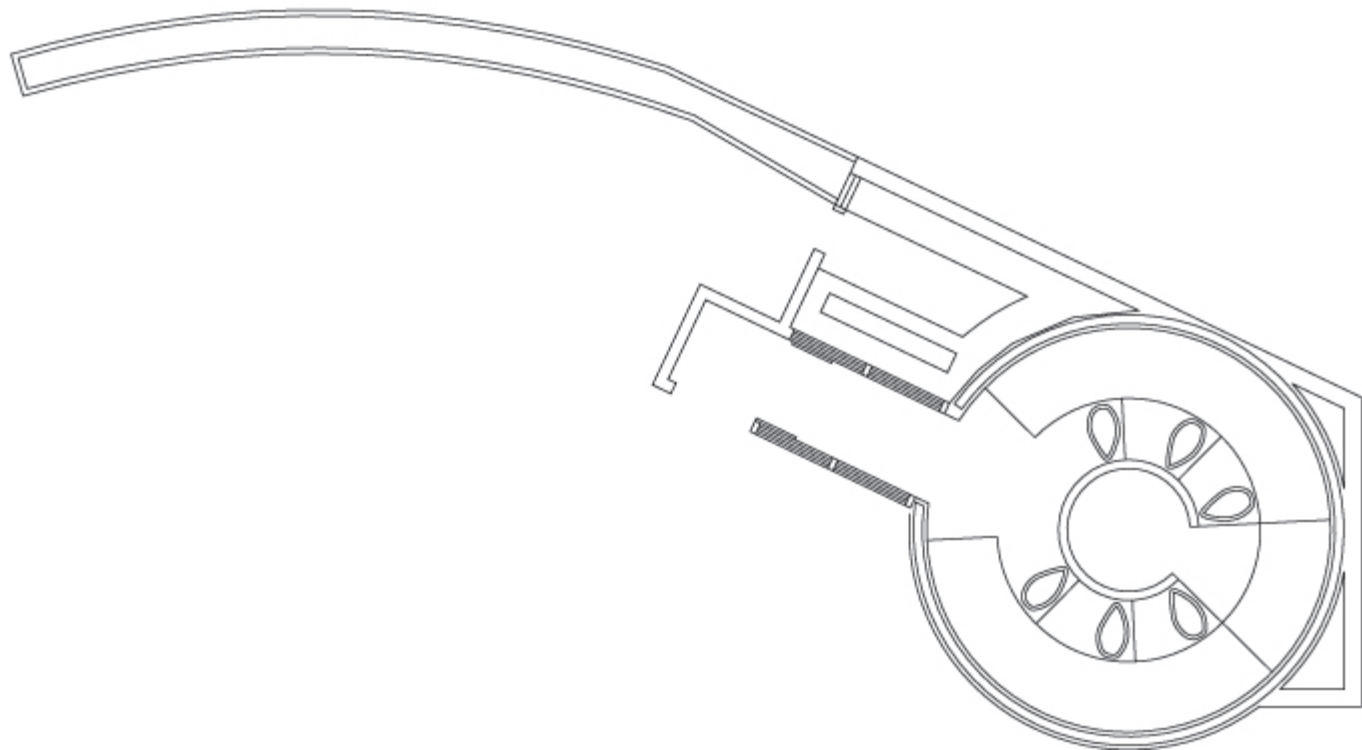



# Circulation

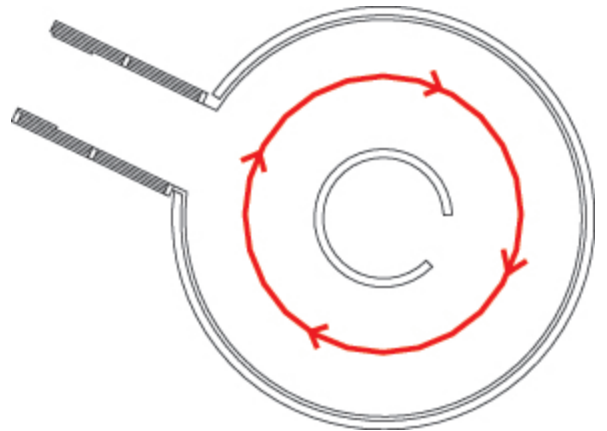

How do we tell the story of  
food production?

# How do we tell the story of food production?

Planting

Growing

Harvesting

Transporting

Selling

Eating

Decomposing

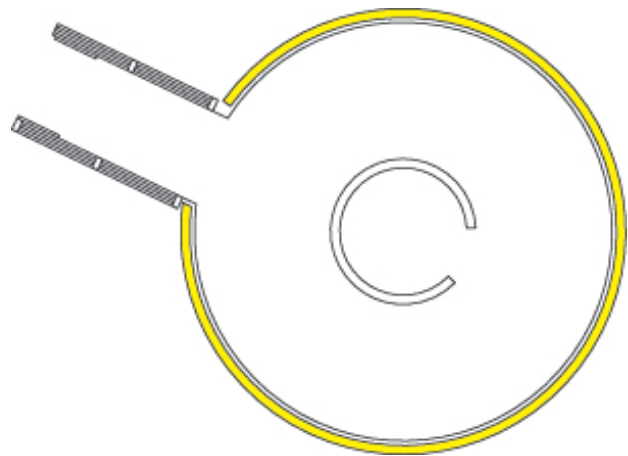

## SECTION OF STORY WALL

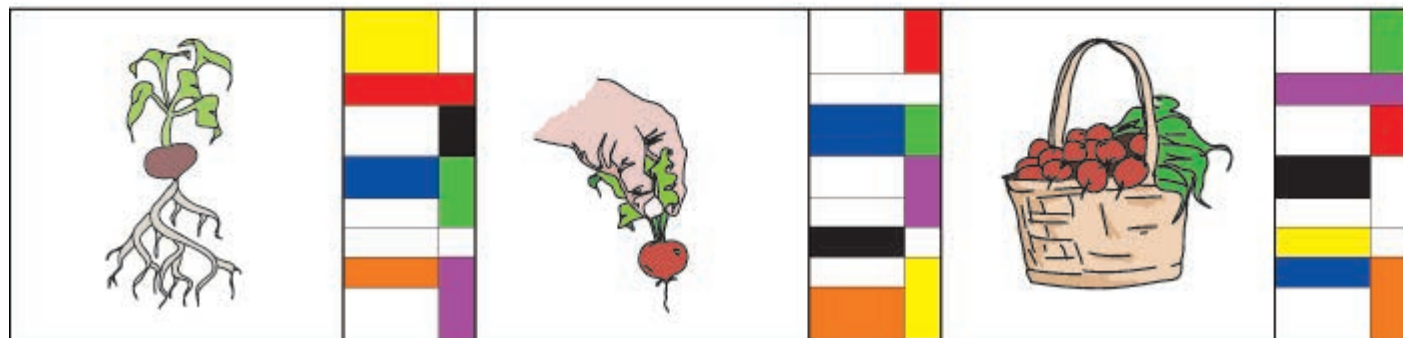
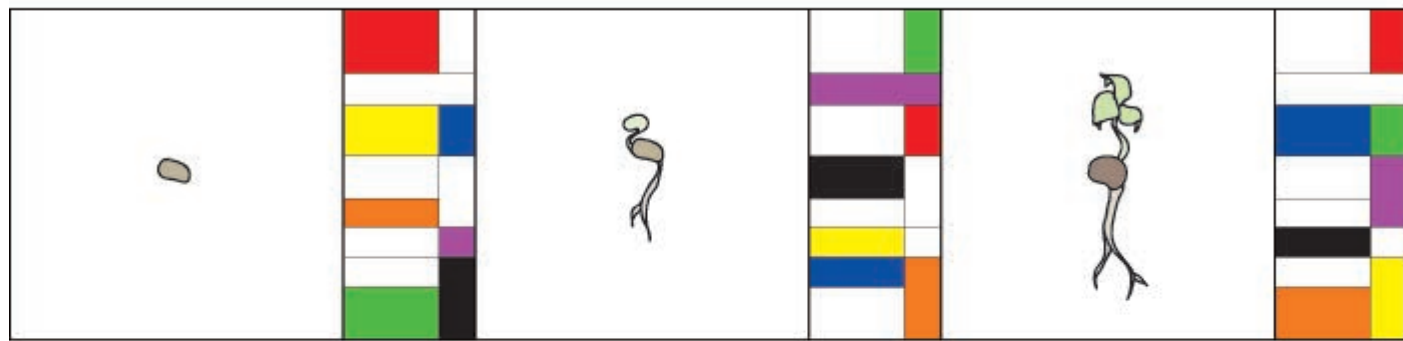



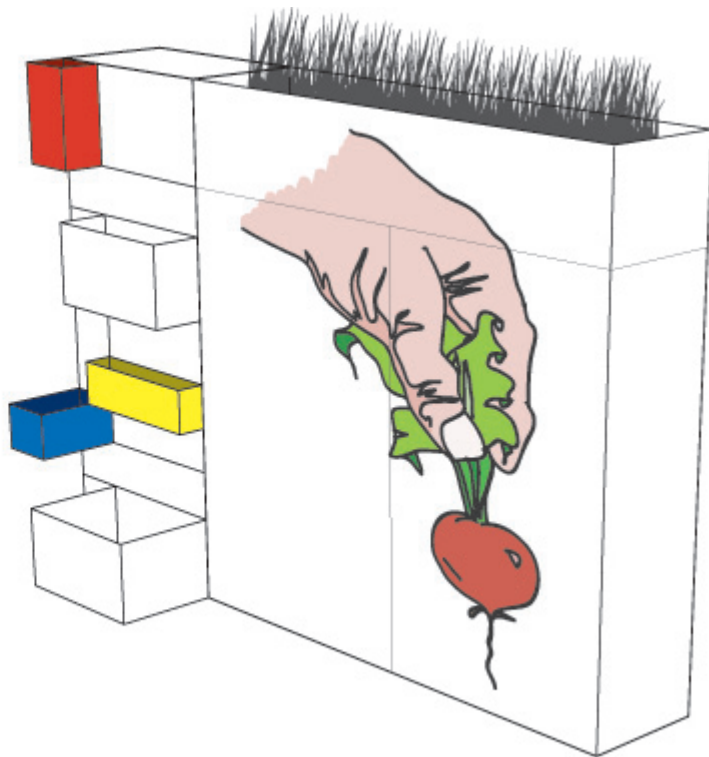

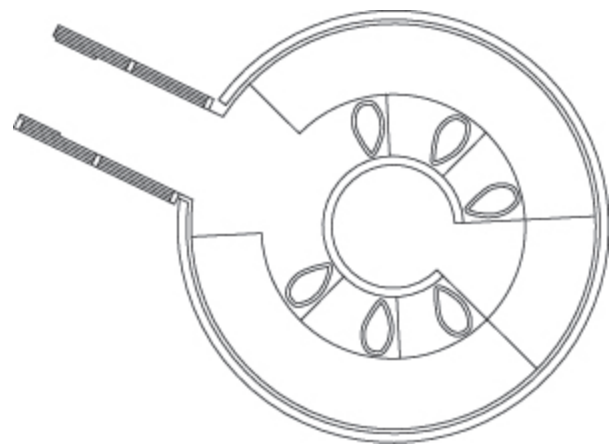



I  
D E O



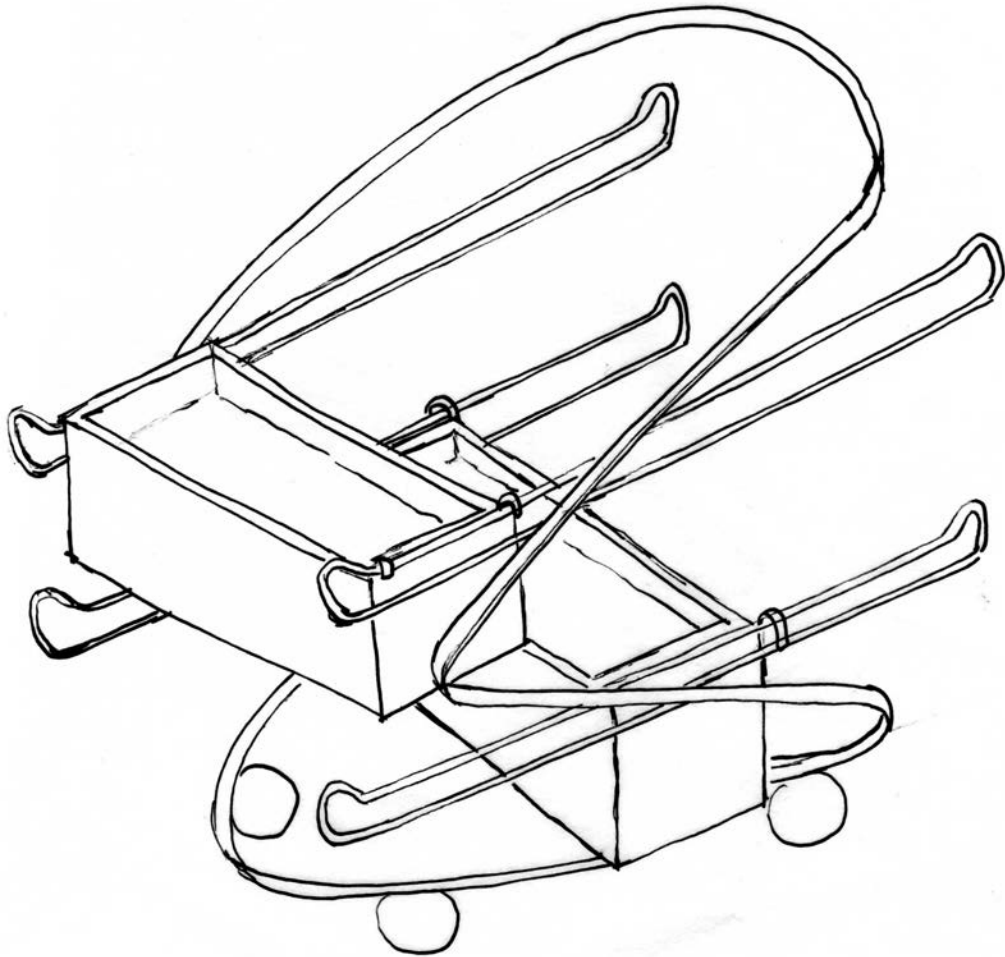



NUTRIENTS



FOOD

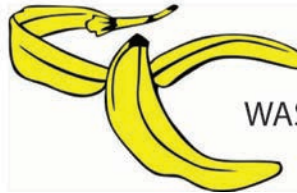

WASTE



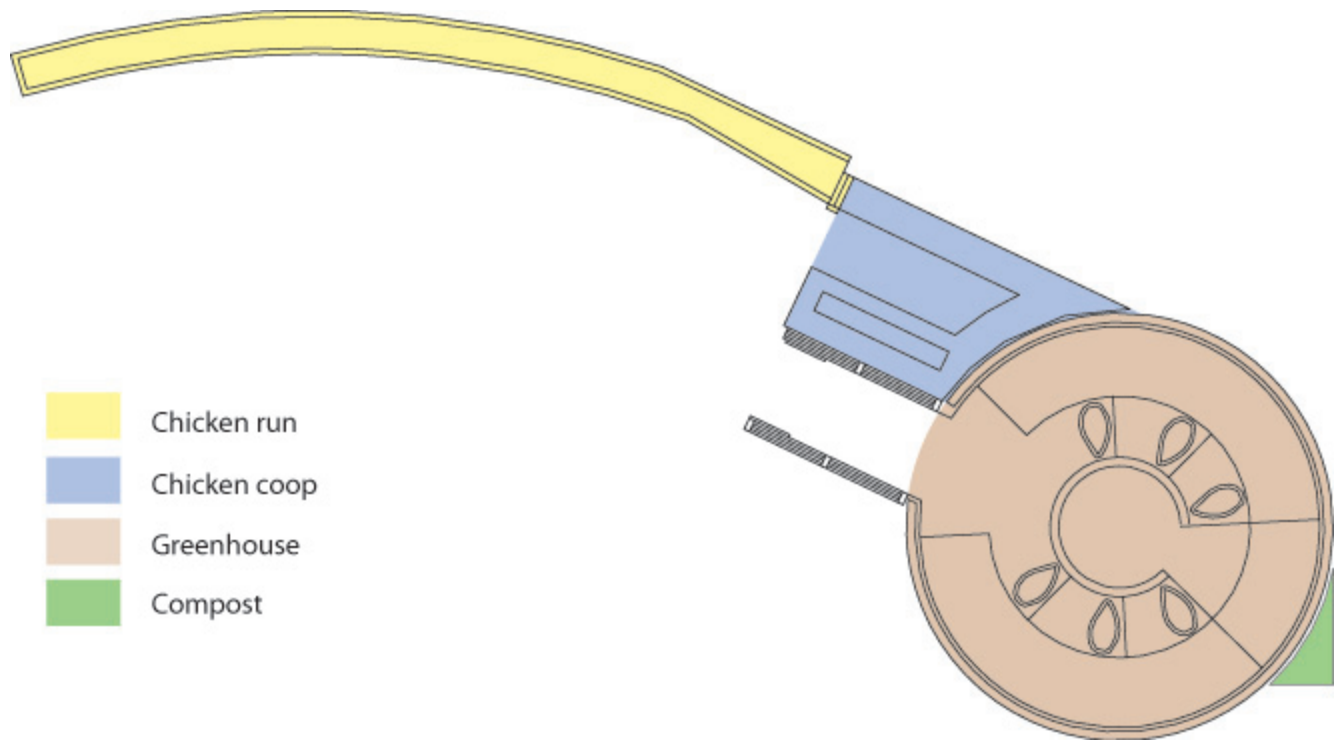

One last story...

One last story...

**Sun and atmosphere.**

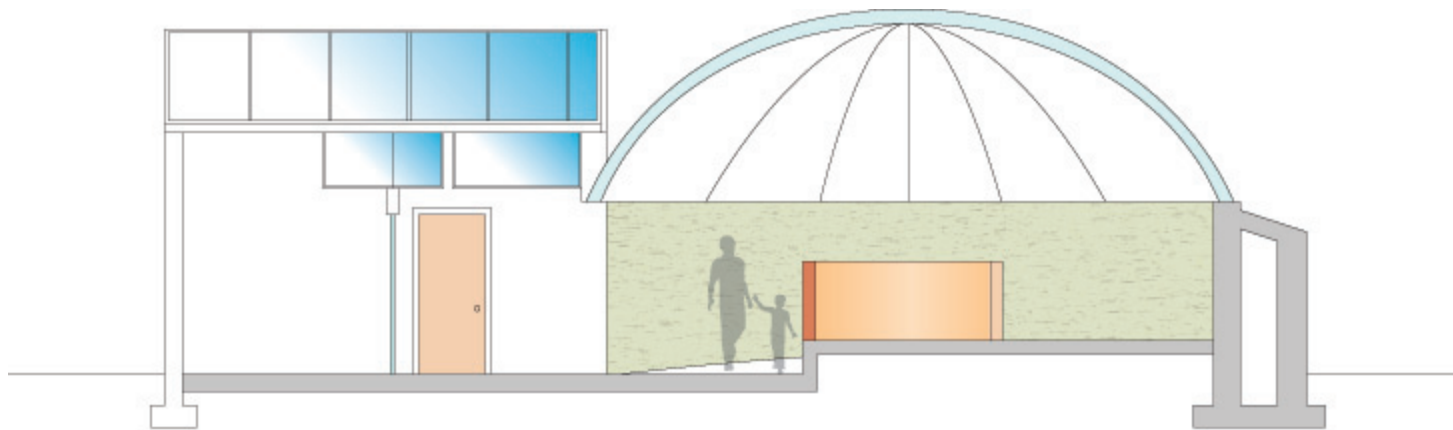

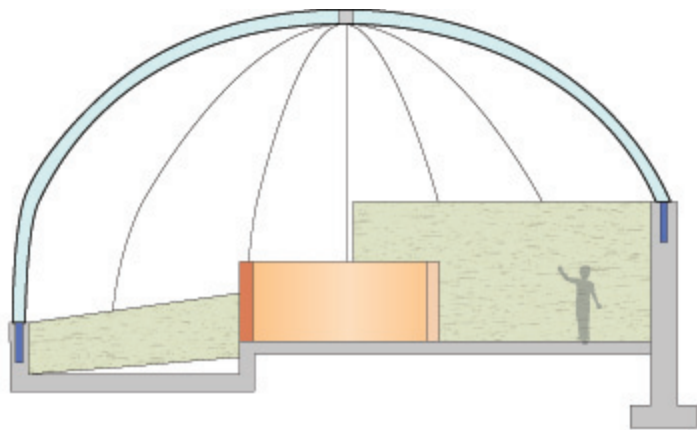



Also, bubbles are **Cool.**







**Thanks from Team Super Cycle!**